

Video Conferencing Phone VCP41

The Yealink Video Conferencing Phone VCP41 is a perfect choice for Video conferencing systems that delivers superior performance for small to medium-sized meeting rooms. The VCP41 video conferencing phone can be used as the speakerphone and microphone for the endpoint. It supports 360-degree audio pickup at a radius of up to 3 meters to achieve ultra-HD voice. With an included expansion microphone KIT, the voice pickup range can be extended to up to 5 meters. You can also connect to a mobile phone or PC for conference calls via a 3.5mm port for a more convenient conference call experience. 14 KHz CD level broadband audio quality, plus a number of new leading-edge professional voice processing technologies, guarantee users an excellent audio experience and make your conference calls more efficient and productive.

Key Features and Benefits

- Optima HD voice, full duplex technology
- One-button to make presentation, recording and redial
- 10-foot (3-meter) 360° voice pickup
- Built-in 3-microphone array
- 320ms echo cancellation tail length
- Plus two expansion microphones for wider reception
- Seamless connection to mobile phones or PCs



Features

- Optima HD voice
- 10-foot (3-meter) 360° microphone pickup
- 16-foot (5-meter) microphone pickup with CPE80
- Built-in speakerphone
- Built-in 3-microphone array
- 112 mm diameter and 2.7w speaker
- Bi-color LED
- Echo cancellation tail length is up to 320ms
- Background noise suppression
- VAD (Voice Activity Detection)
- CNG (Comfort Noise Generator)
- AEC (Acoustic Echo Canceling)

Physical features

- 1 x mobile phone/PC port: 3.5mm
- Dimension (W*D*H): 320mm x 260mm x 52mm
- Operating humidity: 10~95%
- Storage temperature: -10~50°C

Certification

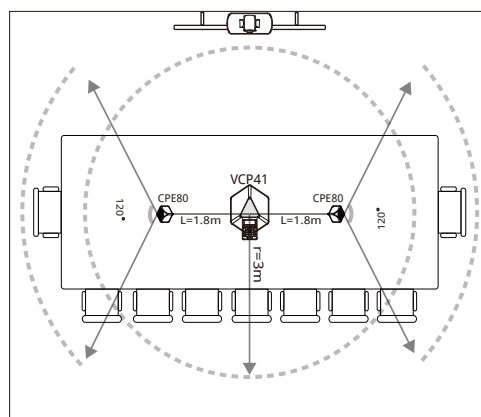
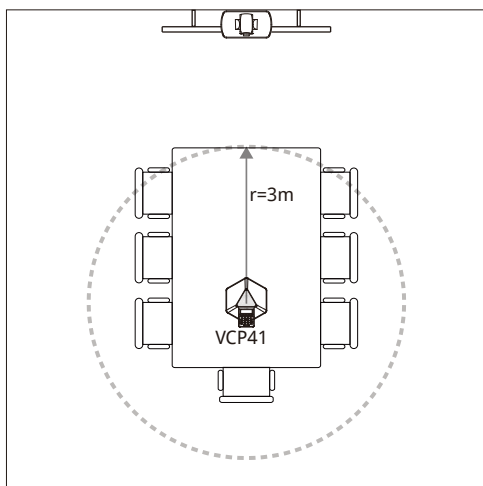

Video Conferencing Phone VCP40

The Yealink Video Conferencing Phone VCP40 is a best choice for Video conferencing systems that delivers superior performance for small to medium-sized meeting rooms. The VCP40 video conferencing phone can be used as the speakerphone and microphone for the endpoint. It supports 360-degree audio pickup at a radius of up to 3 meters to achieve ultra-HD voice. With an optional expansion microphone KIT, the voice pickup range can be extended to up to 5 meters. 14 KHz CD level broadband audio quality, plus a number of new leading-edge professional voice processing technologies, guarantee users an excellent audio experience and make your conference calls more efficient and productive.

Key Features and Benefits

- Optima HD voice, full duplex technology
- One-button to make presentation, recording and redial
- 10-foot (3-meter) 360° voice pickup
- Built-in 3-microphone array
- 320ms echo cancellation tail length
- Optional expansion microphones for wider reception



Optima HD Voice



Expansion Microphone



Speakerphone



Microphone Array



Keypad

Features

- Optima HD voice
- 10-foot (3-meter) microphone pickup
- Built-in speakerphone
- 112 mm diameter and 2.7w speaker
- Built-in 3-microphone array
- 360 degree voice pickup

- Bi-color LED
- Echo cancellation tail length is up to 320ms
- Background noise suppression
- VAD (Voice Activity Detection)
- CNG (Comfort Noise Generator)
- AEC (Acoustic Echo Canceling)

Physical features

- Dimension (W*D*H): 320mm x 260m x 52mm
- Operating humidity: 10~95%
- Storage temperature: -10~50°C

Certification

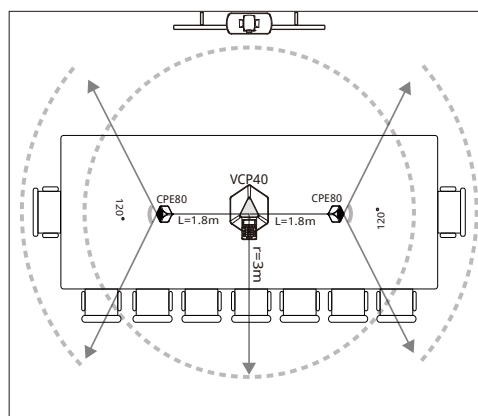
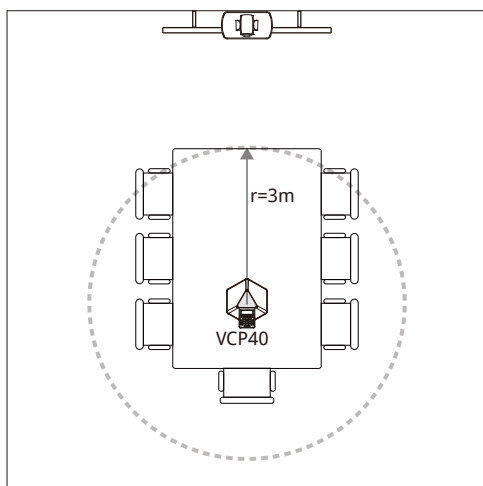

Video Conferencing Microphone Array VCM30

The VCM30 is a video conferencing microphone array which can work as the audio input device for VC120/VC110 video conferencing endpoint. It has 3 built-in microphones which support 360-degree audio pickup at a radius of up to 3 meters. The Yealink VCM30 reduces ambient room noise and features superior audio technology that automatically steers its three microphones toward the person speaking for greater voice pickup. The VCM30 is a clear-cut choice for organizations which enables optimal microphone placement and room coverage.

Key Features and Benefits

- Optima HD voice, full duplex technology
- 10-foot (3-meter) 360° voice pickup
- Capacitive mute touchpad with bicolor LED
- Built in 3-microphone array
- Echo cancellation



Optima HD Voice



Capacitive Mute Touchpad



Microphone Array

Features

- Optima HD voice
- Muting the microphone with touchpad
- 10-foot (3-meter) microphone pickup
- Built in 3-microphone array
- 360 degree voice pickup

- Echo cancellation tail length is up to 320ms
- Background noise suppression
- VAD (Voice Activity Detection)
- CNG (Comfort Noise Generator)
- AEC (Acoustic Echo Canceling)

Physical features

- Dimension (W*D*H): 104mm x 117mm x 22mm
- Operating humidity: 10~95%
- Storage temperature: -10~50°C

Certification

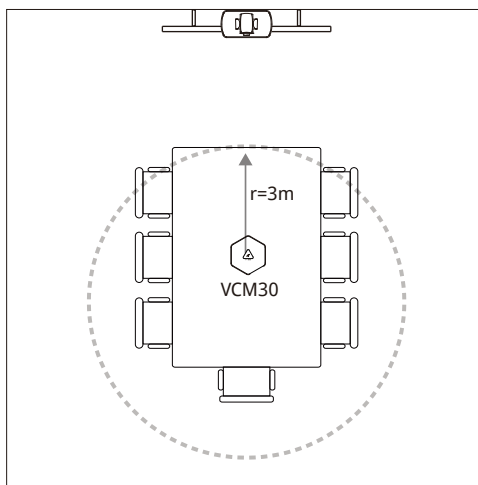

Video Conferencing Wireless Microphone VCM60

The Yealink VCM60 is a video conferencing wireless microphone which can work as the audio input device for VC110 video conferencing endpoint. It supports 360-degree audio pickup at a radius of up to 2 meters. The Yealink VCM60 reduces ambient room noise and features superior audio technology that automatically steers its microphone toward the person speaking for greater voice pickup. The VCM60 is a clear-cut choice for organizations which enables optimal microphone placement and room coverage.

Key Features and Benefits

- Optima HD voice, full duplex technology
- 6.6-foot (2-meter) 360° voice pickup
- Capacitive mute touchpad with bicolor LED
- Echo cancellation
- Dect 6.0



Optima
HD Voice



Capacitive
Mute Touchpad



Wireless
Micpod



USB Charge

Features

- Optima HD voice
- Muting the microphone with touchpad
- 6.6-foot (2-meter) 360° voice pickup
- Optimal distance (between VCM60 and USB Dongle): 50 meters

- 2710mAh battery capacity
- 72 hours talking time
- 36 days standby time
- VAD (Voice Activity Detection)
- CNG (Comfort Noise Generator)
- AEC (Acoustic Echo Canceling)

Physical features

- Dimension (W*D*H): 104mm x 117mm x 22mm
- Operating humidity: 10~95%
- Storage temperature: -10~50°C

Certification

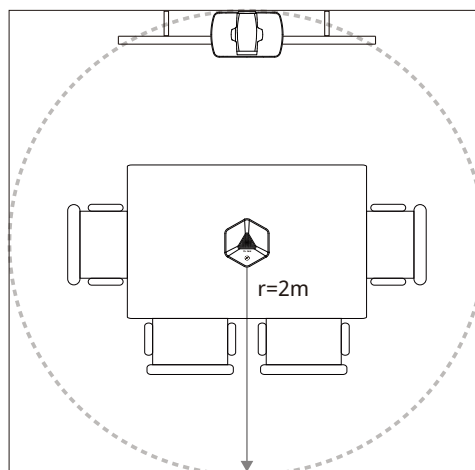

Expansion Microphone CPE80 for Yealink VCS Phone and Conference Phone

The Yealink CPE80 expansion microphone for Yealink VCS phone and conference phone is a directional microphone, which supports 120-degree audio pickup and should be faced to the speaker. Up to two expansion microphones can be connected to an IP conference phone, which extend the range of the video conferencing phone by an additional 10 feet respectively. Advanced echo cancellation and noise suppression filter out unwanted sound, so all that remains is crystal-clear voice. The CPE80 is a clear-cut choice for organizations which enables optimal microphone placement and room coverage.

Key Features and Benefits

- Optima HD voice, full duplex technology
- 10-foot (3-meter) 120°H voice pickup
- Capacitive mute touchpad with bicolor LED
- Echo cancellation



Optima
HD Voice



Capacitive
Mute Touchpad

Features

- Optima HD voice
- 10-foot (3-meter) 120°H voice pickup
- Muting the microphone with touchpad
- Bi-color LED
- Echo cancellation tail length is up to 320ms
- Background noise suppression





- VAD (Voice Activity Detection)
- CNG (Comfort Noise Generator)
- AEC (Acoustic Echo Canceling)

Physical features

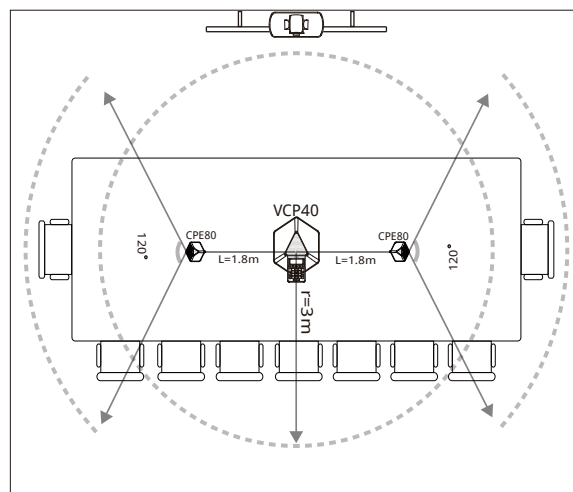
- 1 x RJ9 (4P4C) port for connecting to Yealink Video Conferencing Phone
- Dimension (W*D*H): 104mm x 117mm x 22mm
- Operating humidity: 10~95%
- Storage temperature: -10~50°C

Certification



					
Microphone Array	√(3)	√(3)	√(3)	x (1)	x (1)
Speaker	√	√	x	x	x
Connctcion	Wired	Wired	Wired	Wireless	Wired
LCD Display	√	√	x	x	x
Dial Keypad	√	√	x	x	x
Expansion Microphone	√	√	x	x	x
RJ9 (4P4C) Port	√	√	x	x	x
RJ45 (8P8C) Port	√	√	√	x	x
3.5mm Port (pc-mobile mode)	√	x	x	x	x
Battery Capacity	x	x	x	2710mAh	x
Battery Life	x	x	x	72 hours talking time 36 days standby time	x
Microphone Pickup Radius	360°/10ft (3 meters) 16ft/5 meters with CPE80	360°/10ft (3 meters)	360°/10ft (3 meters)	360°/6.6ft (2 meters)	120°H/10ft (3 meters)
Full Duplex	√	√	√	√	√
AEC (Acoustic Echo Canceling)	√	√	√	√	√
CNG (Comfort Noise Generator)	√	√	√	√	√
VAD (Voice Activity Detection)	√	√	√	√	√
Dimension (W*D*H)	320mm x 260m x 52mm	320mm x 260m x 52mm	104mm x 117mm x 22mm	104mm x 117mm x 22mm	104mm x 117mm x 22mm
Operating Humidity	10~95%	10~95%	10~95%	10~95%	10~95%
Storage Temperature	-10~50°C	-10~50°C	-10~50°C	-10~50°C	-10~50°C
Certification	CE/FCC/A-tick/REACH/IOS 9001	CE/FCC/A-tick/REACH/IOS 9001	CE/FCC/A-tick/REACH/IOS 9001	CE/FCC/A-tick/REACH/IOS 9001	CE/FCC/A-tick/REACH/IOS 9001